

SPLIT WITH DUCTED EVAPORATOR SYSTEM

- Discreet device
- Constant temperature maintenance by heating or cooling
- Preservation of humidity
- Adjustable temperature from 4 to 15 °C
- Low noise level
- Automatic defrost

A NEW GENERATION OF **AIR CONDITIONERS** FOR WINE CELLAR

SPLIT SP40 DU PRO/4/8



WINE MASTER[®]
le temps d'être différent

EQUIPMENT

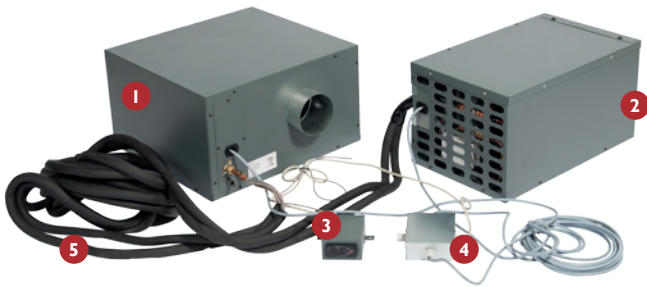

- 1 Evaporator (inside unit)
- 2 Condensation unit (outside unit)
- 3 Thermostat
- 4 Wiring box
- 5 Preloaded connecting ducts for the 4 & 8 m version

FILTER VIEW

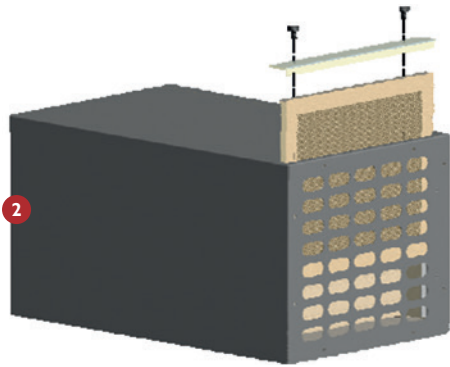

THERMOSTAT



INSTALLATION ABOVE A WINE CELLAR

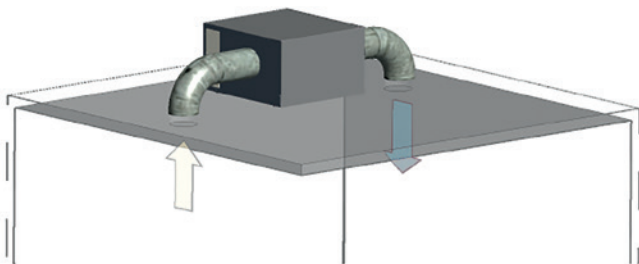

EXPLODED VIEW

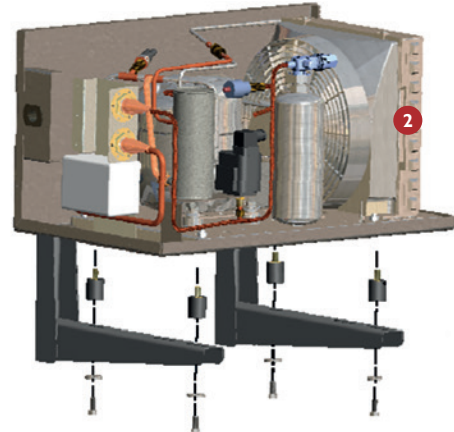

- Regulator
- Fan speed controller
- Automatic high pressure switch
- Automatic low pressure switch
- Filter
- Safety valve
- Wall brackets supplied with anti vibration pads

INSTALLATION PRINCIPLE

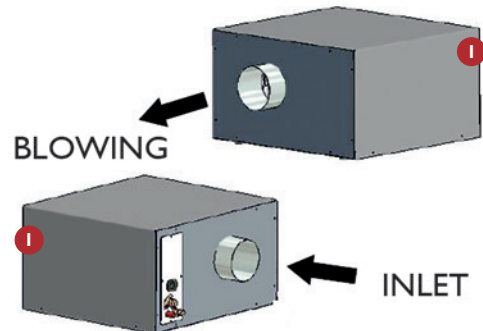

INSTALLATION NEXT TO A WINE CELLAR

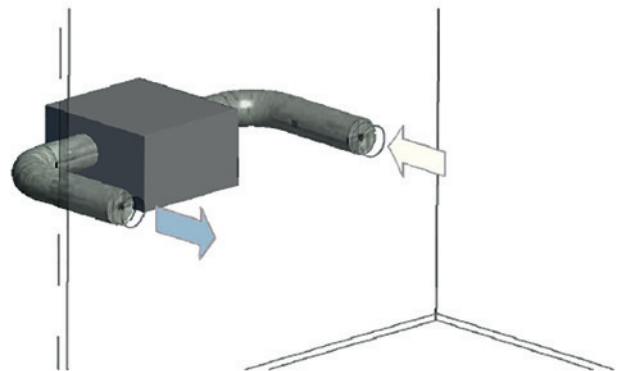

The WineMaster SP40 DU is available in 3 versions : the classic Split model for connections with a maximum distance of 20 m and 10 m in elevation and two preloaded models with insulated flexible connection length of 4 or 8 m for an easy installation between the inside and the outside.

TECHNICAL DRAWINGS

Front view outside unit :

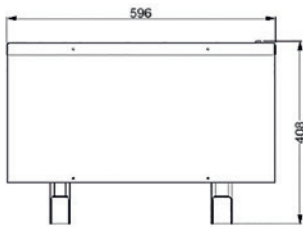

Side view outside unit :

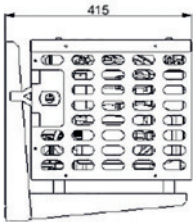

Front view evaporator unit :

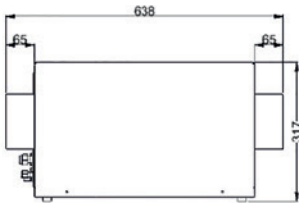

Side view evaporator unit :

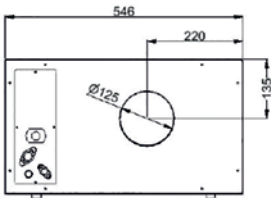

Thermostat front view :

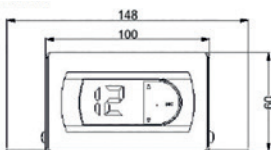

Thermostat side view :

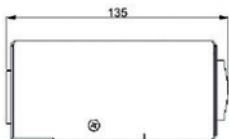

Wiring box front view :

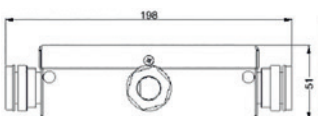

Wiring box side view :

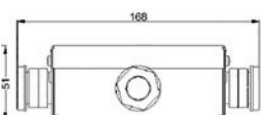

TECHNICAL DATA

Reference	SP40 DU PRO	SP40 DU PRO 4	SP40 DU PRO 8
Volume (m ³)	up to 40m ³ depending of insulation		
Cooling power (watt)	900		
Heating power (watt)	500		
Condenser unit (outside unit)			
Air flow (m ³ /h)	980 (without filter)		
Noise level (db)	59 (1m) / 49 (5m)		
Noise level with sound insulation option (db)	49 (1m) / 39 (5m)		
Weight (kg)	35		
Dimensions H x W x D (mm)	408 x 633 x 415		
Color finish	RAL 7012		
Refrigerant	R404		
Automatic high pressure switch	●		
Automatic low pressure switch	●		
Regulator and fan speed controller	●		
Oil separator	●		
Safety valve	●		
Sealed wiring box	●		
Preloaded refrigerant connection length	/	4	8
Preloaded refrigerated connection length	1/4 and 3/8	/	/
Washable air filter	●		
Heating belt	●		
Evaporator (inside unit)			
Weight (kg)	26		
Dimensions H x W x D (mm)	317 x 638 x 546		
Color finish	RAL 7012		
Speed rate	2		
Nozzle section (mm)	125		
Supplied grids	2		
Drier	●		
Regulator	●		
Heating resistance	●		
Regulation	wire control		

Trust in **FONDIS** know-how and experience for the achievement of the wine cellar you ever dreamed of.

THE KEYS OF OUR SUCCESS :

- Constant temperature maintenance
- Controlled humidity
- Temperature setting between 4 & 15°C
- Serial heating
- Reduced noise level
- Automatic defrost

To take care about your wine capital, we have taken the following technical precautions :

- Regulator and fan speed controller
- Automatic low & high pressure switch
- Safety valve
- Heating belt
- Metallic dust filter

THE WINE CELLAR IN THE CENTRE OF ALL ATTENTIONS

Real wine cabinet either for wine lovers or professionals, the wine cellar can now be installed directly into the living spaces.

Wine Master offers a complete range, more than 20 years of experience and thousands of realizations, an advanced design while ensuring a great discretion.

SPLIT SP 40

THE NEW GENERATION OF AIR CONDITIONER FOR WINE CELLAR

In order to answer to the requirements of glazed wine cabinets, Wine Master is launching a new range of air conditioner for wine cellars: SPLIT SP40.

Passionate wine lovers or professionals, your wine collection needs the most beautiful display for everyone to enjoy.

The Winemaster range has been built to provide most favorable cooling solution in the cellar of your dreams. Through constant temperature and controlled humidity, your wines grow up throughout the year in a wine cellar with preserved conditions even under extreme temperatures (minus 30°C to + 40°C).

CONTACT US :

WINEMASTER

Z.I. de Vieux-Thann - 18 rue Guy de Place

BP 60010 - F 68801 THANN Cedex

Tél. : + 33 (0)3 89 377 500

Fax : + 33 (0)3 89 377 589

E-mail : contact@winemaster.fr

www.winemaster.fr



WINE MASTER®
le temps d'être différent